

# HL6319G/20G

AlGaInP Laser Diodes

# HITACHI

ADE-208-479D (Z)  
5th Edition  
Dec. 2000

## Description

The HL6319G/20G are 0.63  $\mu\text{m}$  band AlGaInP laser diodes with a multi-quantum well (MQW) structure. They are suitable as light sources for laser levelers and optical equipment for measurement.

## Application

- Laser levelers
- Measurement

## Features

- Visible light output: 635 nm Typ (nearly equal to He-Ne gas laser)
- Optical output power: 10 mW CW
- Low operating current: 95 mA Max
- Low operating voltage: 2.7 V Max
- TM mode oscillation

Package Type  
• HL6319G/20G: G2

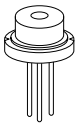

Internal Circuit  
• HL6319G

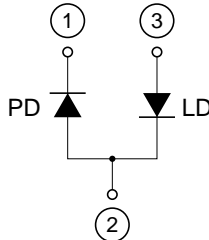

Internal Circuit  
• HL6320G

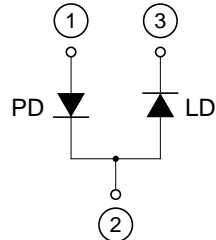

**Absolute Maximum Ratings** ( $T_C = 25^\circ\text{C}$ )

Item	Symbol	Rated Value	Unit
Optical output power	$P_O$	10	mW
LD reverse voltage	$V_{R(LD)}$	2	V
PD reverse voltage	$V_{R(PD)}$	30	V
Operating temperature	$T_{opr}$	-10 to +50	$^\circ\text{C}$
Storage temperature	$T_{stg}$	-40 to +85	$^\circ\text{C}$

**Optical and Electrical Characteristics** ( $T_C = 25^\circ\text{C}$ )

Item	Symbol	Min	Typ	Max	Unit	Test Conditions
Optical output power	$P_O$	10	—	—	mW	Kink free
Threshold current	$I_{th}$	20	50	75	mA	
Operating current	$I_{OP}$	—	70	95	mA	$P_O = 10\text{ mW}$
Operating voltage	$V_{OP}$	—	—	2.7	V	$P_O = 10\text{ mW}$
Slope efficiency	$\eta_s$	0.3	0.5	0.7	mW/mA	$6\text{ (mW)} / (I_{(8\text{mW})} - I_{(2\text{mW})})$
Beam divergence parallel to the junction	$\theta_{//}$	5	8	11	deg.	$P_O = 10\text{ mW}$
Beam divergence perpendicular to the junction	$\theta_{\perp}$	25	31	37	deg.	$P_O = 10\text{ mW}$
Astigmatism	$A_s$	—	5	—	$\mu\text{m}$	$P_O = 10\text{ mW}$ , $NA = 0.55$
Lasing wavelength	$\lambda_p$	625	635	640	nm	$P_O = 10\text{ mW}$
Monitor current	$I_s$	0.05	0.17	0.30	mA	$P_O = 10\text{ mW}$ , $V_{R(PD)} = 5\text{ V}$

Typical Characteristic Curves

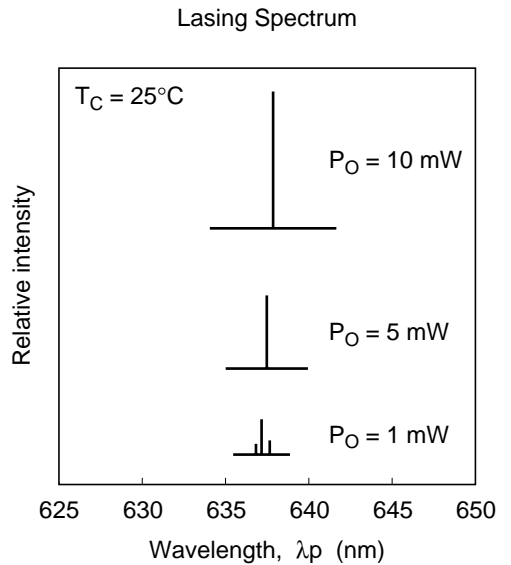
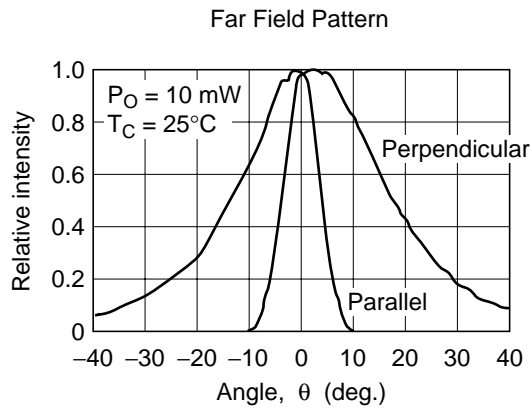
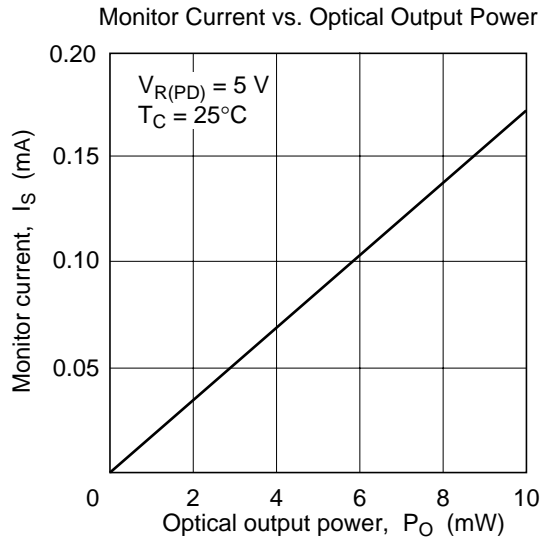
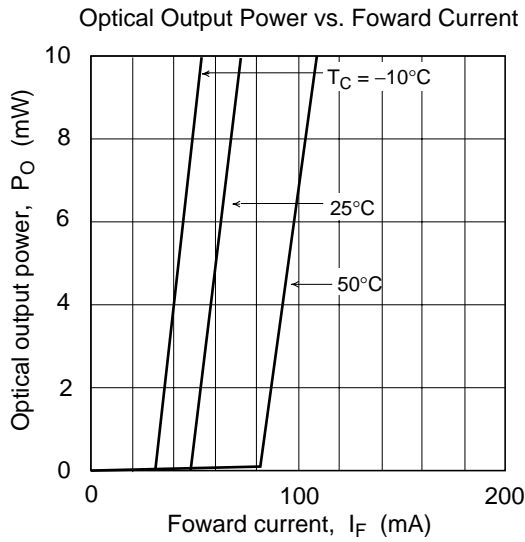

Typical Characteristic Curves (cont)

Threshold Current vs. Case Temperature

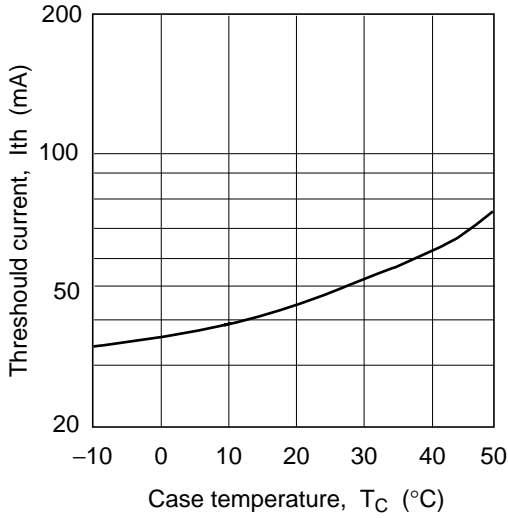

Slope Efficiency vs. Case Temperature

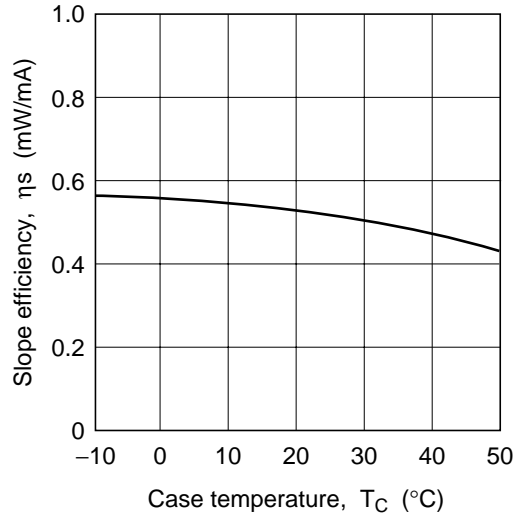

Monitor Current vs. Case Temperature

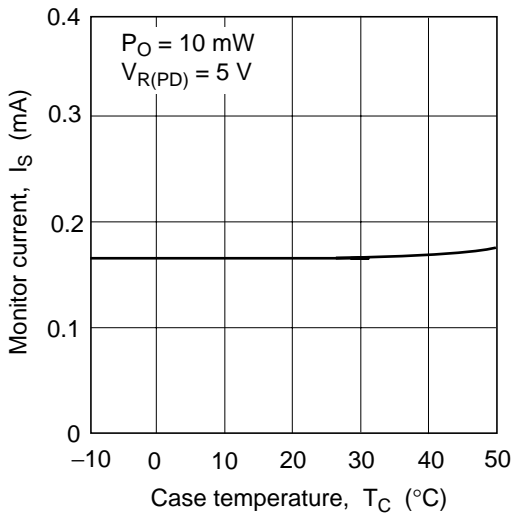

Lasing Wavelength vs. Case Temperature

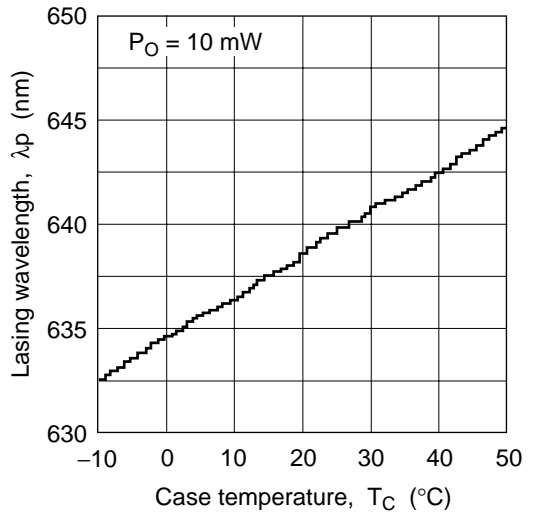

Typical Characteristic Curves (cont)

Astigmatism vs. Optical Output Power

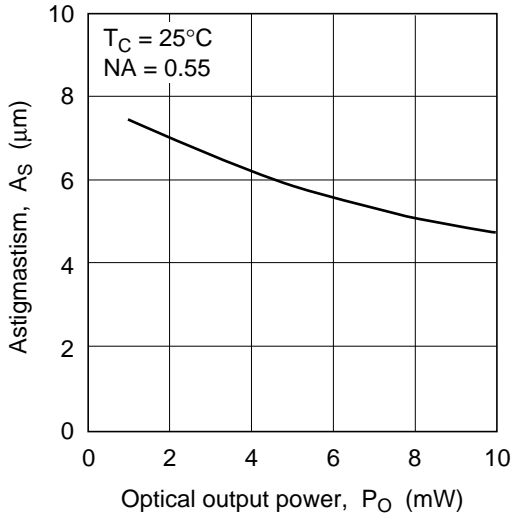

Polarization Ratio vs. Optical Output Power

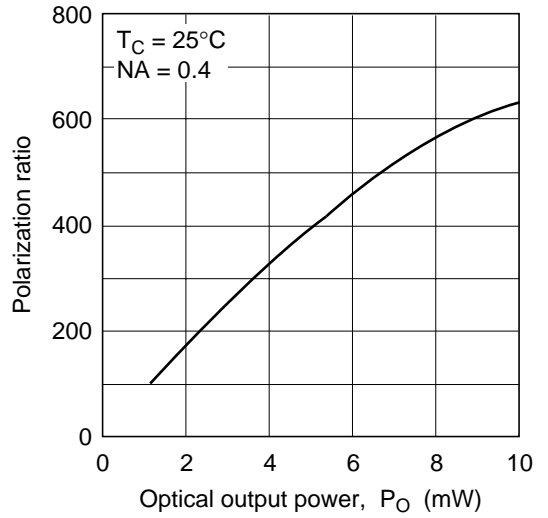

Electrostatic Destruction (Forward)

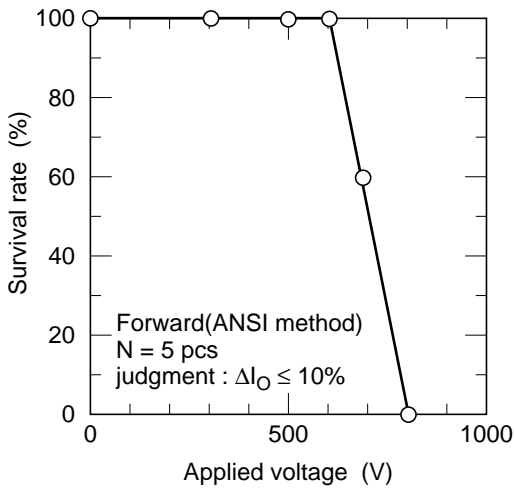

Electrostatic Destruction (Reverse)

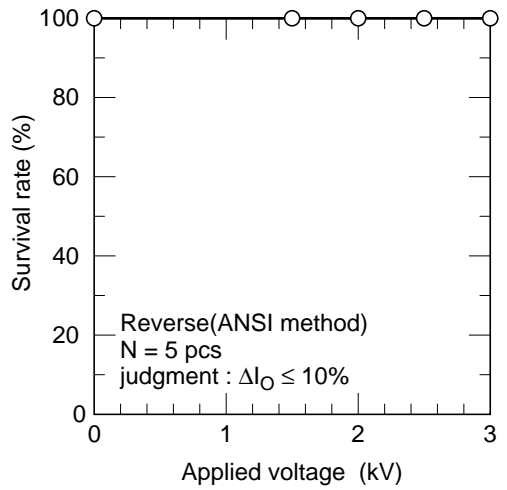

## Package Dimensions

Unit: mm

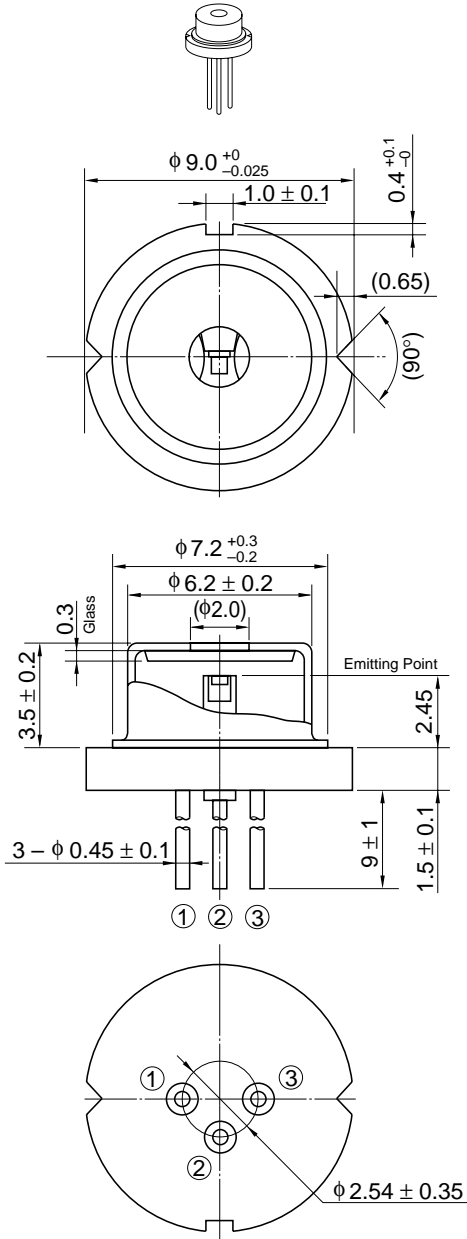

Hitachi Code	LD/G2
JEDEC	—
EIAJ	—
Mass (reference value)	1.1 g

**Cautions**

1. Hitachi neither warrants nor grants licenses of any rights of Hitachi's or any third party's patent, copyright, trademark, or other intellectual property rights for information contained in this document. Hitachi bears no responsibility for problems that may arise with third party's rights, including intellectual property rights, in connection with use of the information contained in this document.
2. Products and product specifications may be subject to change without notice. Confirm that you have received the latest product standards or specifications before final design, purchase or use.
3. Hitachi makes every attempt to ensure that its products are of high quality and reliability. However, contact Hitachi's sales office before using the product in an application that demands especially high quality and reliability or where its failure or malfunction may directly threaten human life or cause risk of bodily injury, such as aerospace, aeronautics, nuclear power, combustion control, transportation, traffic, safety equipment or medical equipment for life support.
4. Design your application so that the product is used within the ranges guaranteed by Hitachi particularly for maximum rating, operating supply voltage range, heat radiation characteristics, installation conditions and other characteristics. Hitachi bears no responsibility for failure or damage when used beyond the guaranteed ranges. Even within the guaranteed ranges, consider normally foreseeable failure rates or failure modes in semiconductor devices and employ systemic measures such as fail-safes, so that the equipment incorporating Hitachi product does not cause bodily injury, fire or other consequential damage due to operation of the Hitachi product.
5. This product is not designed to be radiation resistant.
6. No one is permitted to reproduce or duplicate, in any form, the whole or part of this document without written approval from Hitachi.
7. Contact Hitachi's sales office for any questions regarding this document or Hitachi semiconductor products.

1. The laser light is harmful to human body especially to eye no matter what directly or indirectly. The laser beam shall be observed or adjusted through infrared camera or equivalent.

---

---

# HITACHI

**Hitachi, Ltd.**

Semiconductor &amp; Integrated Circuits.

Nippon Bldg., 2-6-2, Ohte-machi, Chiyoda-ku, Tokyo 100-0004, Japan

Tel: Tokyo (03) 3270-2111 Fax: (03) 3270-5109

URL	NorthAmerica	: <a href="http://semiconductor.hitachi.com/">http://semiconductor.hitachi.com/</a>
	Europe	: <a href="http://www.hitachi-eu.com/hel/ecg">http://www.hitachi-eu.com/hel/ecg</a>
	Asia	: <a href="http://sicapac.hitachi-asia.com">http://sicapac.hitachi-asia.com</a>
	Japan	: <a href="http://www.hitachi.co.jp/Sicd/indx.htm">http://www.hitachi.co.jp/Sicd/indx.htm</a>

**For further information write to:**

Hitachi Semiconductor  
(America) Inc.  
179 East Tasman Drive,  
San Jose, CA 95134  
Tel: <1> (408) 433-1990  
Fax: <1> (408) 433-0223

Hitachi Europe GmbH  
Electronic Components Group  
Dornacher Straße 3  
D-85622 Feldkirchen, Munich  
Germany  
Tel: <49> (89) 9 9180-0  
Fax: <49> (89) 9 29 30 00

Hitachi Europe Ltd.  
Electronic Components Group.  
Whitebrook Park  
Lower Cookham Road  
Maidenhead  
Berkshire SL6 8YA, United Kingdom  
Tel: <44> (1628) 585000  
Fax: <44> (1628) 585160

Hitachi Asia Ltd.  
Hitachi Tower  
16 Collyer Quay #20-00,  
Singapore 049318  
Tel: <65>-538-6533/538-8577  
Fax: <65>-538-6933/538-3877  
URL: <http://www.hitachi.com.sg>

Hitachi Asia Ltd.  
(Taipei Branch Office)  
4/F, No. 167, Tun Hwa North Road,  
Hung-Kuo Building,  
Taipei (105), Taiwan  
Tel: <886>-(2)-2718-3666  
Fax: <886>-(2)-2718-8180  
Telex: 23222 HAS-TP  
URL: <http://www.hitachi.com.tw>

Hitachi Asia (Hong Kong) Ltd.  
Group III (Electronic Components)  
7/F., North Tower,  
World Finance Centre,  
Harbour City, Canton Road  
Tsim Sha Tsui, Kowloon,  
Hong Kong  
Tel: <852>-(2)-735-9218  
Fax: <852>-(2)-730-0281  
URL: <http://www.hitachi.com.hk>

Copyright © Hitachi, Ltd., 2000. All rights reserved. Printed in Japan.  
Colophon 2.0

**HITACHI**